



N-channel Power MOSFET

PRODUCT SUMMARY

V_{DS} (V) at T_J max.	650	
$R_{DS(on)}$ max. at 25°C (mΩ)	$V_{GS}=10V$	75
Q_g max. (nC)	90	
Q_{gs} (nC)	17	
Q_{gd} (nC)	30	
Configuration	single	

Features

- New Technology For High Voltage Device
- $I_D=46A(V_{GS}=10V)$
- Ultra Low Gate Charge
- Improved dv/dt Capability
- RoHS compliant



TO-220F

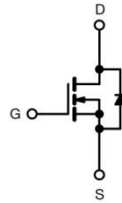

Schematic diagram

Applications

- Switching Mode Power Supplies (SMPS)
- Server and Telecom Power Supplies
- Welding & Battery Chargers
- Solar (PV Inverters)
- AC/DC Bridge Circuits

ORDERING INFORMATION

Device	SPC60R75G
Device Package	TO-220F
Marking	60R75G

ABSOLUTE MAXIMUM RATINGS ($T_C = 25^\circ\text{C}$, unless otherwise noted)

Parameter	Symbol	Limit	Unit
Drain to Source Voltage	V_{DSS}	600	V
Continuous Drain Current (@ $T_C=25^\circ\text{C}$)	I_D	46 ⁽¹⁾	A
Continuous Drain Current (@ $T_C=100^\circ\text{C}$)		28 ⁽¹⁾	A
Drain current pulsed ⁽²⁾	I_{DM}	138 ⁽¹⁾	A
Gate to Source Voltage	V_{GS}	± 30	V
Single pulsed Avalanche Energy ⁽³⁾	E_{AS}	1200	mJ
MOSFET dv/dt ruggedness (@ $V_{DS}=0\sim 400V$)	dv/dt	25	V/ns
Peak diode Recovery dv/dt ⁽⁴⁾	dv/dt	15	V/ns
Total power dissipation (@ $T_C=25^\circ\text{C}$)	P_D	35.7	W
Derating Factor above 25°C		0.28	W/°C
Operating Junction Temperature & Storage Temperature	T_{STG}, T_J	-55 to + 150	°C
Maximum lead temperature for soldering purpose	T_L	260	°C

Notes

1. Drain current is limited by maximum junction temperature.
2. Repetitive rating : pulse width limited by junction temperature.
3. $L = 37.5\text{mH}$, $I_{AS} = 8A$, $V_{DD} = 50V$, $R_G=25\Omega$, Starting at $T_J = 25^\circ\text{C}$
4. $I_{SD} \leq I_D$, $di/dt = 100A/\mu\text{s}$, $V_{DD} \leq BV_{DSS}$, Starting at $T_J = 25^\circ\text{C}$
5. Mounting consideration for TO220 Fullpack:
M3 screw plus flat washer is suggested, free of burr between devices and contact area, the devices are to be mounted to a hole not larger than 3.6mm in contact diameter (chamfer included).



THERMAL CHARACTERISTICS			
Parameter	Symbol	Value	Unit
Thermal resistance, Junction to case	R_{thjc}	3.5	°C/W
Thermal resistance, Junction to ambient	R_{thja}	38	°C/W

ELECTRICAL CHARACTERISTICS ($T_C = 25^\circ\text{C}$ unless otherwise specified)						
Parameter	Symbol	Test conditions	Min.	Typ.	Max.	Unit
Off Characteristics						
Drain to source breakdown voltage	BV_{DSS}	$V_{GS}=0V, I_D=250\mu A$	600	--	--	V
Breakdown voltage temperature coefficient	$\Delta BV_{DSS} / \Delta T_J$	$I_D=250\mu A$, referenced to 25°C	--	0.38	--	V/°C
Drain to source leakage current	I_{DSS}	$V_{DS}=600V, V_{GS}=0V$	--	--	1	μA
		$V_{DS}=480V, T_C=125^\circ\text{C}$	--	120	--	μA
Gate to source leakage current, forward	I_{GSS}	$V_{GS}=30V, V_{DS}=0V$	--	--	100	nA
Gate to source leakage current, reverse		$V_{GS}=-30V, V_{DS}=0V$	--	--	-100	nA
On Characteristics						
Gate threshold voltage	$V_{GS(TH)}$	$V_{DS}=V_{GS}, I_D=250\mu A$	2.5	--	4.5	V
Drain to source on state resistance	$R_{DS(ON)}$	$V_{GS}=10V, I_D=23A$	--	60	75	m Ω
Forward Transconductance	G_{fs}	$V_{DS} = 30V, I_D = 23A$	--	32	--	S
Gate Resistance	R_g	$V_{DS} = 0V$		1.1		Ω
Dynamic Characteristics						
Input capacitance	C_{iss}	$V_{GS}=0V, V_{DS}=200V, f=1\text{MHz}$	--	3220	--	pF
Output capacitance	C_{oss}		--	122	--	
Reverse transfer capacitance	C_{rss}		--	3	--	
Turn on delay time	$t_{d(on)}$	$V_{DS}=300V, I_D=23A, R_G=25\Omega$	--	32	--	ns
Rising time	t_r		--	72	--	
Turn off delay time	$t_{d(off)}$		--	110	--	
Fall time	t_f		--	67	--	
Total gate charge	Q_g	$V_{DS}=480V, V_{GS}=10V, I_D=23A$	--	72	90	nC
Gate-source charge	Q_{gs}		--	17	--	
Gate-drain charge	Q_{gd}		--	30	--	

SOURCE TO DRAIN DIODE RATINGS CHARACTERISTICS						
Parameter	Symbol	Test conditions	Min.	Typ.	Max.	Unit
Continuous source current	I_S	Integral reverse p-n Junction diode in the MOSFET	--	--	46	A
Pulsed source current	I_{SM}		--	--	138	A
Diode forward voltage drop.	V_{SD}	$I_S=23A, V_{GS}=0V$	--	0.9	1.2	V
Reverse recovery time	T_{rr}	$I_S=23A, V_{GS}=0V,$	--	420	--	ns
Reverse recovery Charge	Q_{rr}	$di_f/dt=100A/\mu s$	--	7.2	--	μC



Fig1. Output characteristics

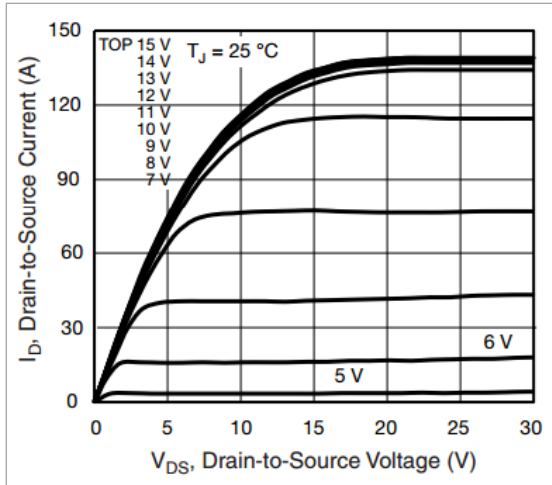

Fig2. - Maximum Drain Current vs. Case Temperature

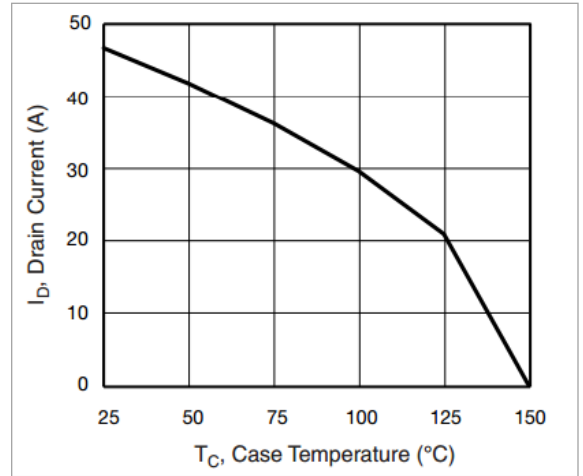

Fig3. Gate charge characteristics

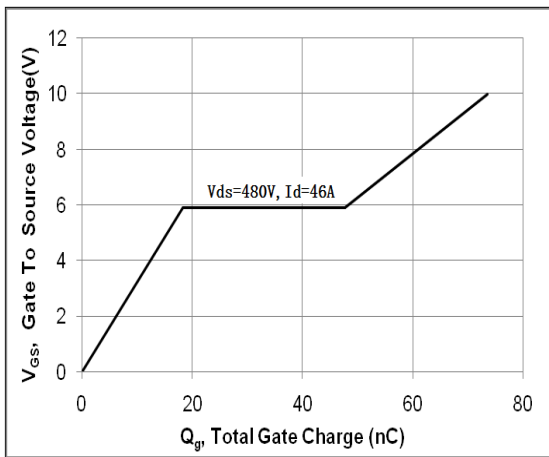

Fig 4. Capacitance Characteristics

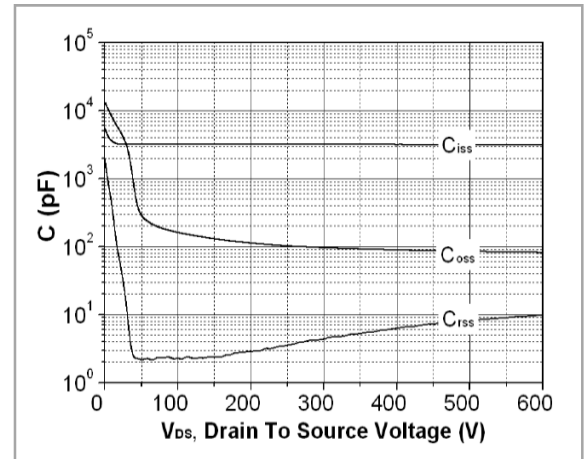

Fig 5. $R_{DS(ON)}$ vs junction temperature

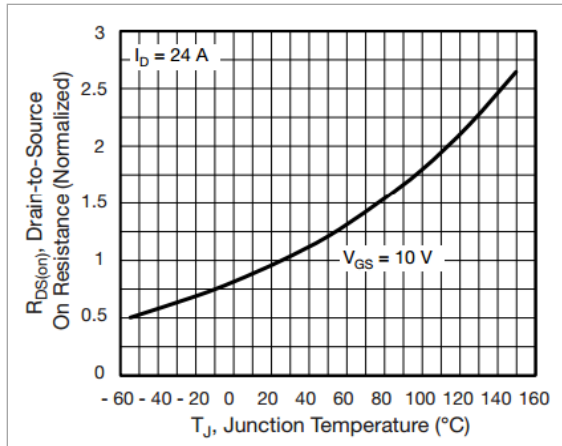

Fig 6. - Temperature vs. Drain-to-Source Voltage

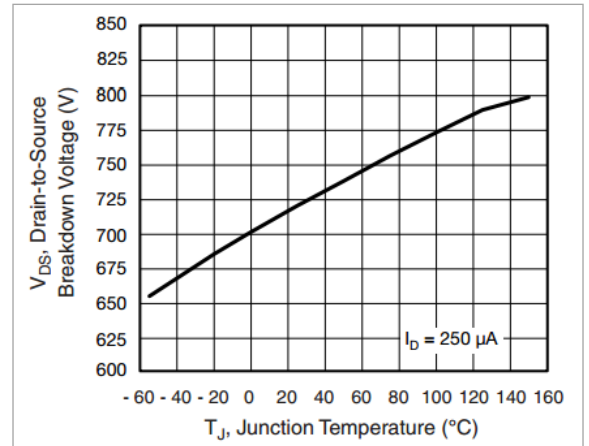

Fig 7 . Safe operating area

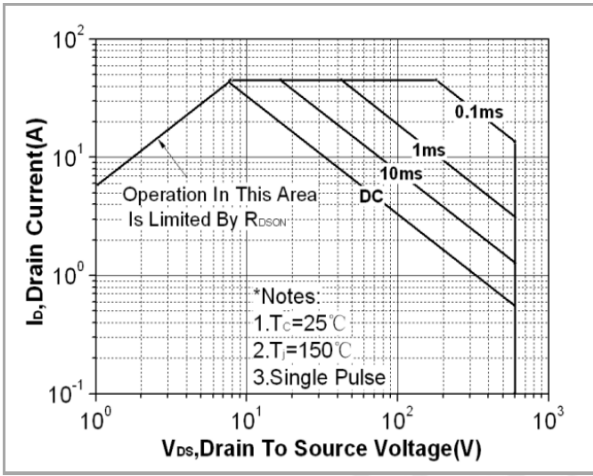

Fig 8. Forward characteristics of reverse diode

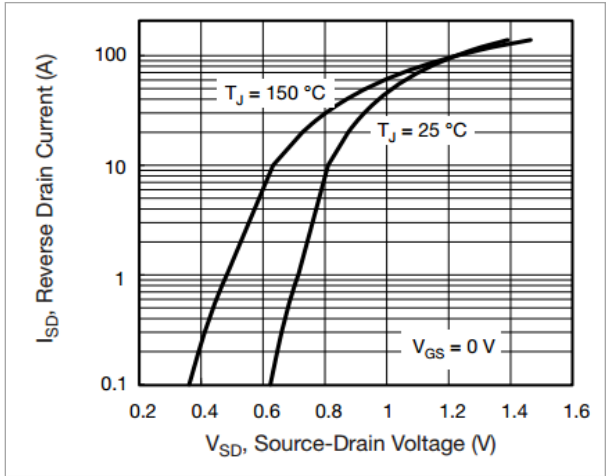

Fig 9 . Transient thermal impedance

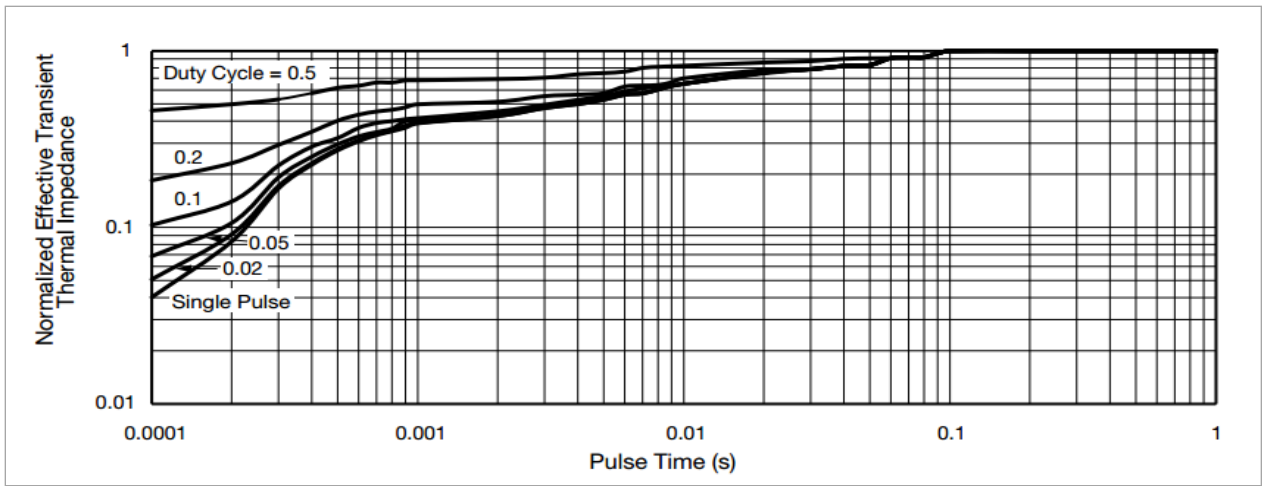

Fig 10. Gate charge test circuit & waveform

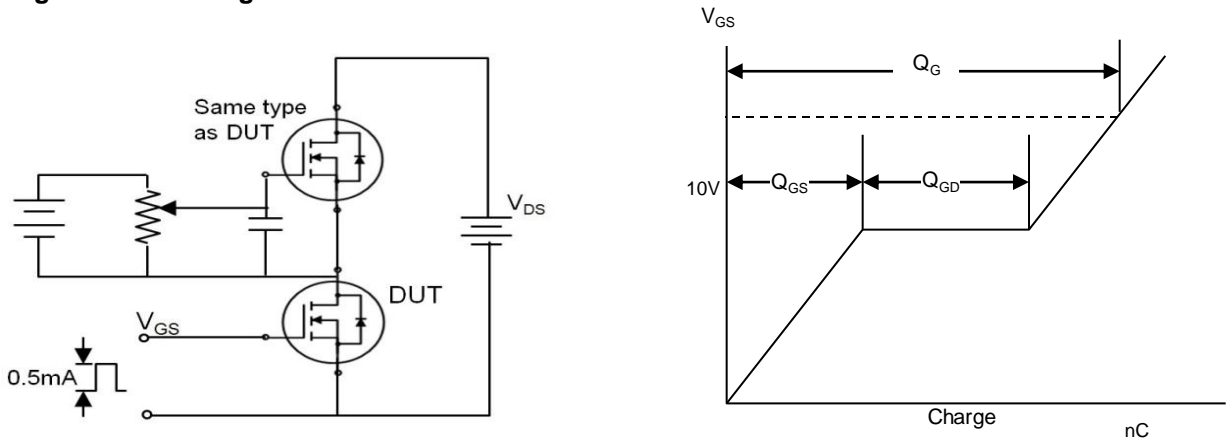

Fig 11. Switching time test circuit & waveform

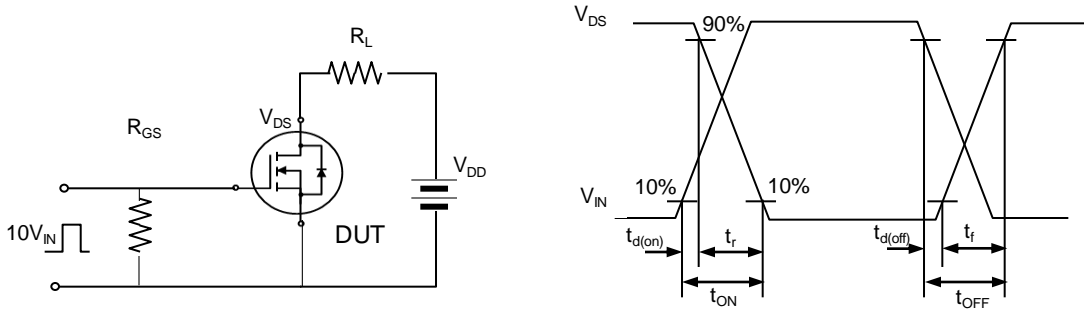

Fig 12. Unclamped Inductive switching test circuit & waveform

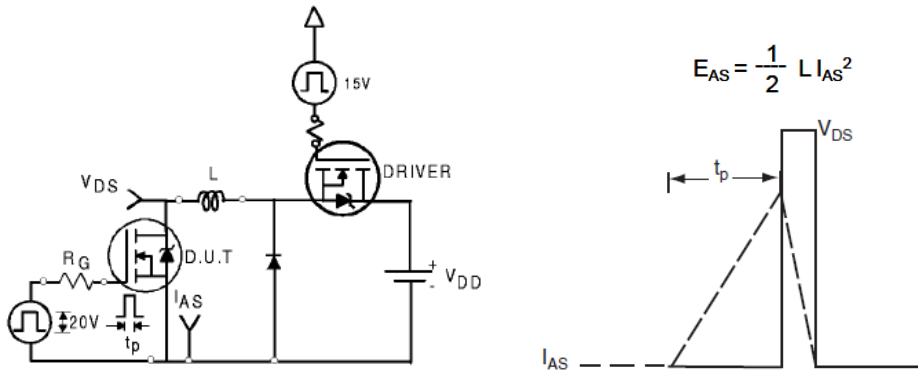
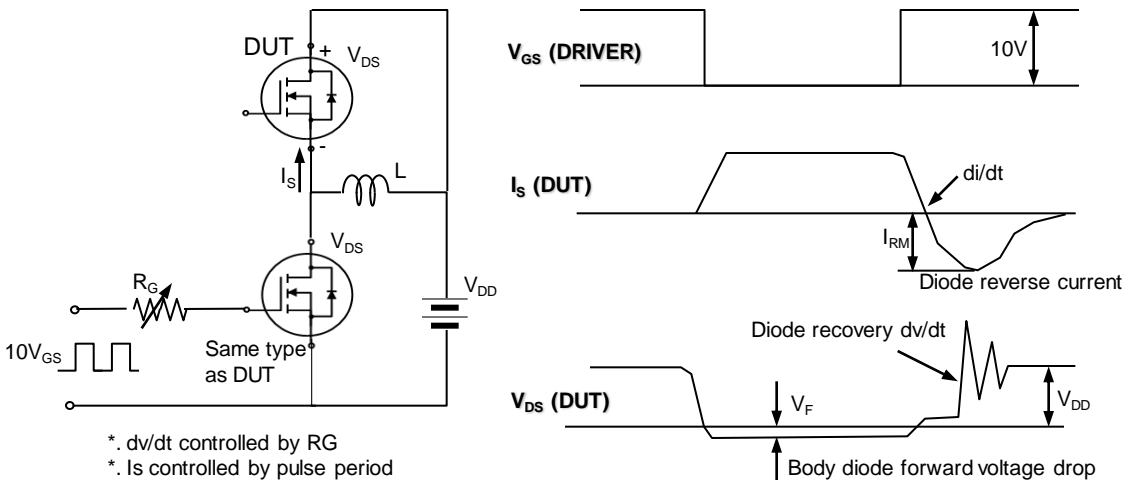

Fig 13. Peak diode recovery dv/dt test circuit & waveform





Disclaimer

- ◆ SINAI assumes no responsibility for equipment failures that result from using products at values that exceed, even momentarily, rated values (such as maximum ratings, operating condition ranges, or other parameters) listed in products specifications of any and all SINAI products described or contained herein.
- ◆ Specifications of any and all SINAI products described or contained herein stipulate the performance, characteristics, and functions of the described products in the independent state, and are not guarantees of the performance, characteristics, and functions of the described products as mounted in the customer's products or equipment. To verify symptoms and states that cannot be evaluated in an independent device, the customer should always evaluate and test devices mounted in the customer's products or equipment.
- ◆ In the event that any or all SINAI products(including technical data, services) described or contained herein are controlled under any of applicable local export control laws and regulations, such products must not be exported without obtaining the export license from the authorities concerned in accordance with the above law.
- ◆ This catalog provides information as of Nov. 2014. Specifications and information herein are subject to change without notice.