

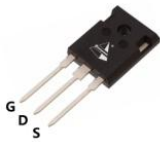

## N-channel Power MOSFET

PRODUCT SUMMARY	
$V_{DS}$ (V) at $T_J$ max.	650
$R_{DS(on)}$ max. at 25°C (mΩ)	$V_{GS}=10V$   70
$Q_g$ max. (nC)	90
$Q_{gs}$ (nC)	17
$Q_{gd}$ (nC)	30
Configuration	single



TO-247

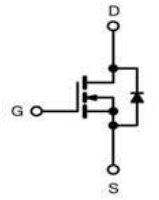

Schematic diagram

## Features

- $I_D=46A$ ( $V_{GS}=10V$ )
- Ultra Low Gate Charge
- Improved  $dv/dt$  Capability
- RoHS compliant

## Applications

- Switching Mode Power Supplies (SMPS)
- Server and Telecom Power Supplies
- Welding & Battery Chargers
- Solar (PV Inverters)
- AC/DC Bridge Circuits

## ORDERING INFORMATION

Device	SPA60R70G
Device Package	TO-247
Marking	60R70G

ABSOLUTE MAXIMUM RATINGS ( $T_C = 25^\circ C$ , unless otherwise noted)

Parameter	Symbol	Limit	Unit
Drain to Source Voltage	$V_{DSS}$	600	V
Continuous Drain Current (@ $T_C=25^\circ C$ )	$I_D$	46 <sup>(1)</sup>	A
Continuous Drain Current (@ $T_C=100^\circ C$ )		28 <sup>(1)</sup>	A
Drain current pulsed <sup>(2)</sup>	$I_{DM}$	138 <sup>(1)</sup>	A
Gate to Source Voltage	$V_{GS}$	$\pm 30$	V
Single pulsed Avalanche Energy <sup>(3)</sup>	$E_{AS}$	900	mJ
MOSFET $dv/dt$ ruggedness (@ $V_{DS}=0\sim 400V$ )	$dv/dt$	25	V/ns
Peak diode Recovery $dv/dt$ <sup>(4)</sup>	$dv/dt$	15	V/ns
Total power dissipation (@ $T_C=25^\circ C$ )	$P_D$	340	W
Derating Factor above 25°C		2.7	W/°C
Operating Junction Temperature & Storage Temperature	$T_{STG}, T_J$	-55 to + 150	°C
Maximum lead temperature for soldering purpose	$T_L$	260	°C

## Notes

1. Drain current is limited by maximum junction temperature.
2. Repetitive rating : pulse width limited by junction temperature.
3.  $L = 36.7mH$ ,  $I_{AS} = 7A$ ,  $V_{DD} = 50V$ ,  $R_G=25\Omega$ , Starting at  $T_J = 25^\circ C$
4.  $I_{SD} \leq I_D$ ,  $di/dt = 100A/us$ ,  $V_{DD} \leq BV_{DSS}$ , Starting at  $T_J = 25^\circ C$



THERMAL CHARACTERISTICS			
Parameter	Symbol	Value	Unit
Thermal resistance, Junction to case	$R_{thjc}$	0.36	°C/W
Thermal resistance, Junction to ambient	$R_{thja}$	38	°C/W

ELECTRICAL CHARACTERISTICS ( $T_C = 25^\circ\text{C}$ unless otherwise specified )						
Parameter	Symbol	Test conditions	Min.	Typ.	Max.	Unit
<b>Off Characteristics</b>						
Drain to source breakdown voltage	$BV_{DSS}$	$V_{GS}=0V, I_D=250\mu A$	600	--	--	V
Breakdown voltage temperature coefficient	$\Delta BV_{DSS} / \Delta T_J$	$I_D=250\mu A$ , referenced to $25^\circ\text{C}$	--	0.38	--	V/°C
Drain to source leakage current	$I_{DSS}$	$V_{DS}=600V, V_{GS}=0V$	--	--	1	$\mu A$
		$V_{DS}=480V, T_C=125^\circ\text{C}$	--	--	50	$\mu A$
Gate to source leakage current, forward	$I_{GSS}$	$V_{GS}=30V, V_{DS}=0V$	--	--	100	nA
Gate to source leakage current, reverse		$V_{GS}=-30V, V_{DS}=0V$	--	--	-100	nA
<b>On Characteristics</b>						
Gate threshold voltage	$V_{GS(TH)}$	$V_{DS}=V_{GS}, I_D=250\mu A$	2.5	--	4.5	V
Drain to source on state resistance	$R_{DS(ON)}$	$V_{GS}=10V, I_D=23A$	--	60	70	m $\Omega$
Forward Transconductance	$G_{fs}$	$V_{DS} = 30 V, I_D = 23A$	--	32	--	S
Gate Resistance	$R_g$	$V_{DS} = 0 V$		1.1		$\Omega$
<b>Dynamic Characteristics</b>						
Input capacitance	$C_{iss}$	$V_{GS}=0V, V_{DS}=200V, f=1\text{MHz}$	--	3220	--	pF
Output capacitance	$C_{oss}$		--	122	--	
Reverse transfer capacitance	$C_{rss}$		--	3	--	
Turn on delay time	$t_{d(on)}$	$V_{DS}=300V, I_D=23A, R_G=25\Omega$	--	32	--	ns
Rising time	$t_r$		--	72	--	
Turn off delay time	$t_{d(off)}$		--	110	--	
Fall time	$t_f$		--	67	--	
Total gate charge	$Q_g$	$V_{DS}=480V, V_{GS}=10V, I_D=23A$	--	72	90	nC
Gate-source charge	$Q_{gs}$		--	17	--	
Gate-drain charge	$Q_{gd}$		--	30	--	

SOURCE TO DRAIN DIODE RATINGS CHARACTERISTICS						
Parameter	Symbol	Test conditions	Min.	Typ.	Max.	Unit
Continuous source current	$I_S$	Integral reverse p-n Junction diode in the MOSFET	--	--	46	A
Pulsed source current	$I_{SM}$		--	--	138	A
Diode forward voltage drop.	$V_{SD}$	$I_S=23A, V_{GS}=0V$	--	0.9	1.2	V
Reverse recovery time	$T_{rr}$	$I_S=23A, V_{GS}=0V,$	--	420	--	ns
Reverse recovery Charge	$Q_{rr}$	$di_f/dt=100A/\mu s$	--	7.2	--	$\mu C$



Fig1. Output characteristics

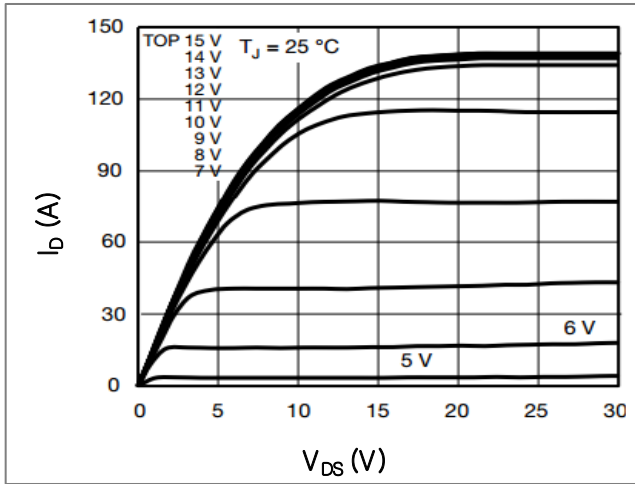

Fig2. - Maximum Drain Current vs. Case Temperature

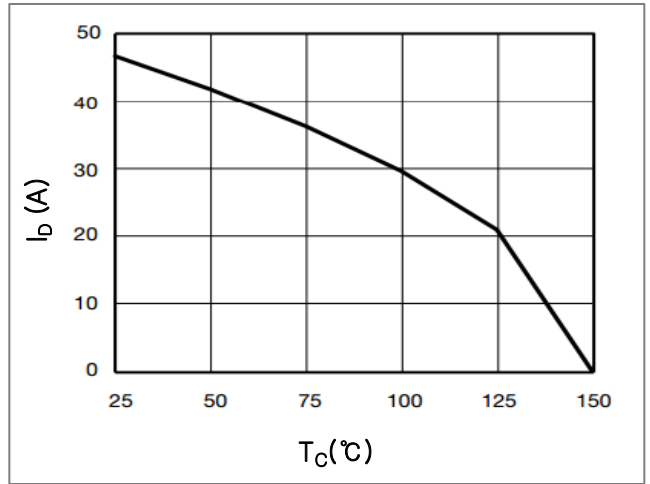

Fig3. Gate charge characteristics

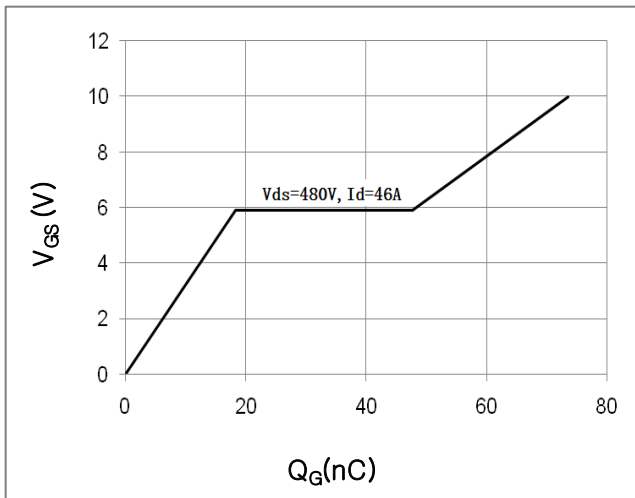

Fig 4. Capacitance Characteristics

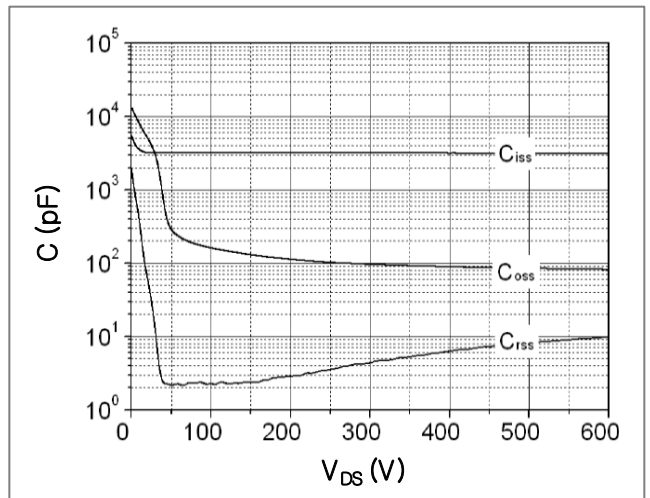

Fig 5.  $R_{DS(ON)}$  vs junction temperature

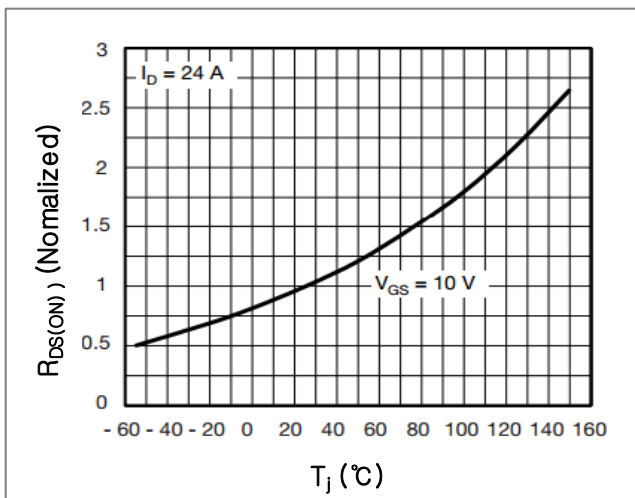

Fig 6. - Temperature vs. Drain-to-Source Voltage

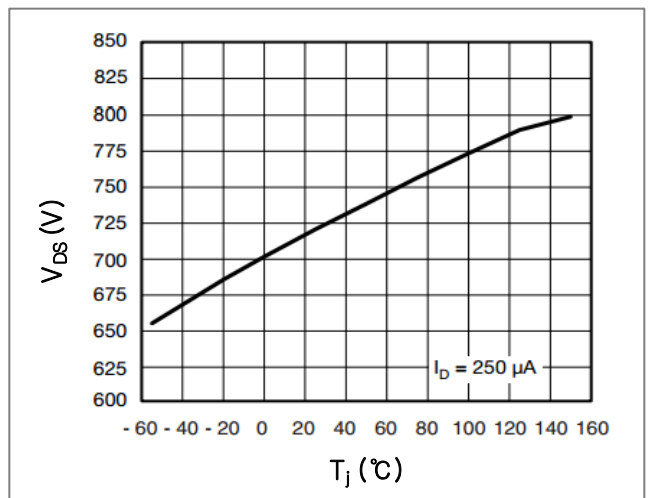

Fig 7 . Safe operating area

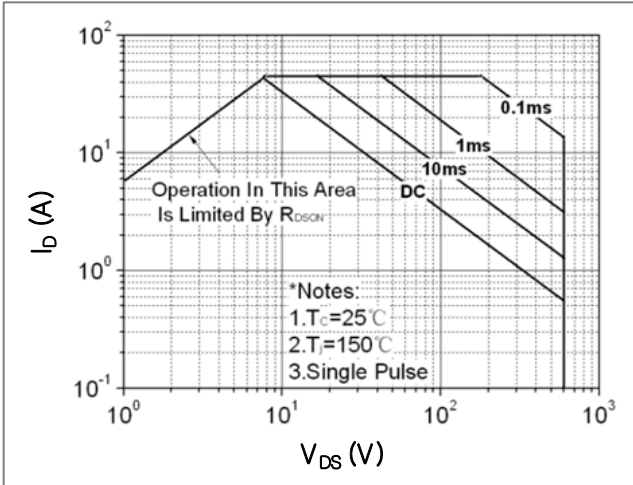

Fig 8. Forward characteristics of reverse diode

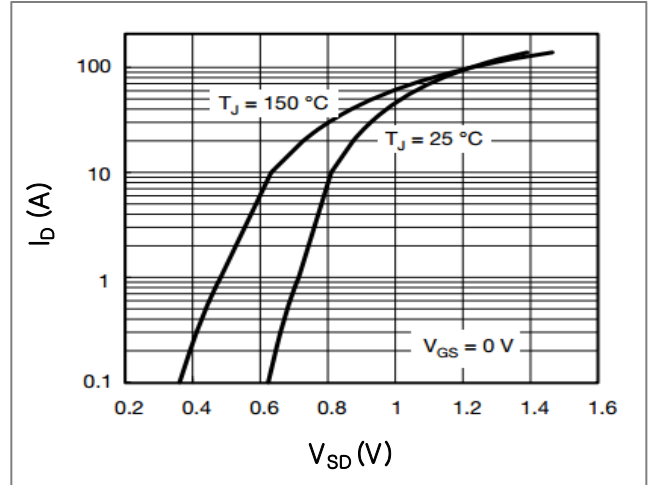

Fig 9 . Transient thermal impedance

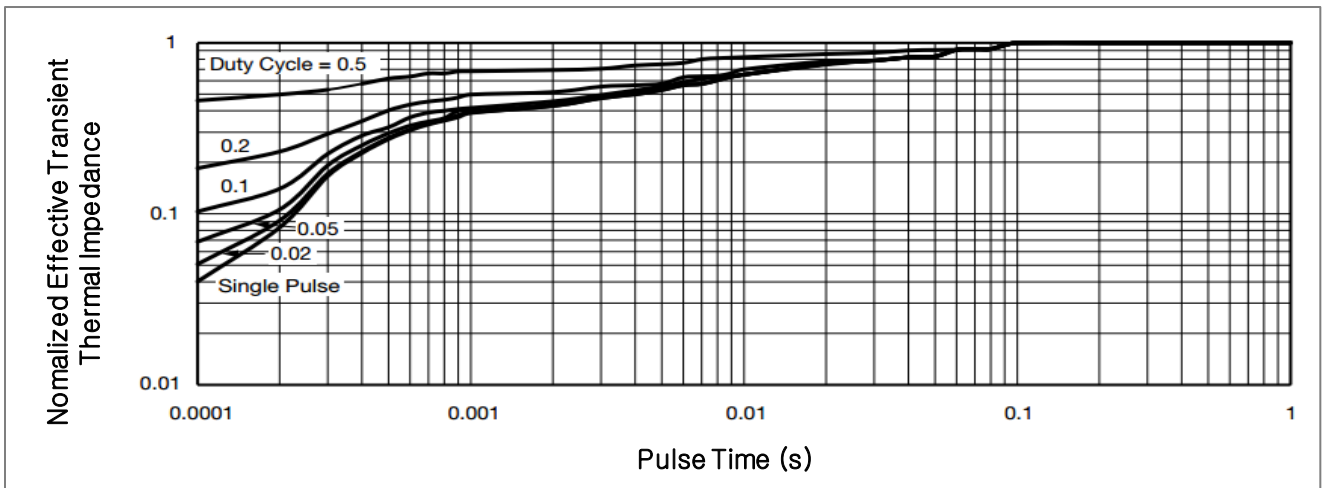

Fig 10. Gate charge test circuit & waveform

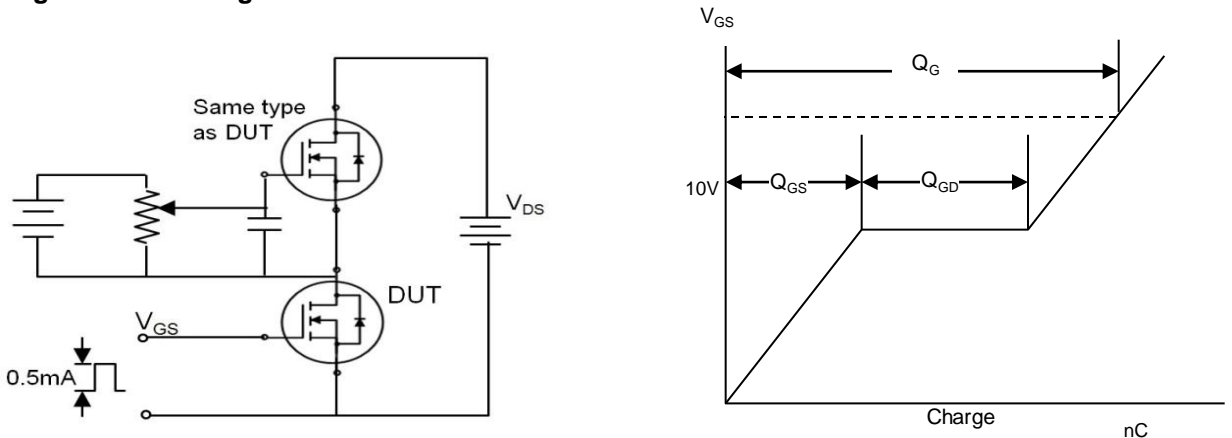

Fig 11. Switching time test circuit & waveform

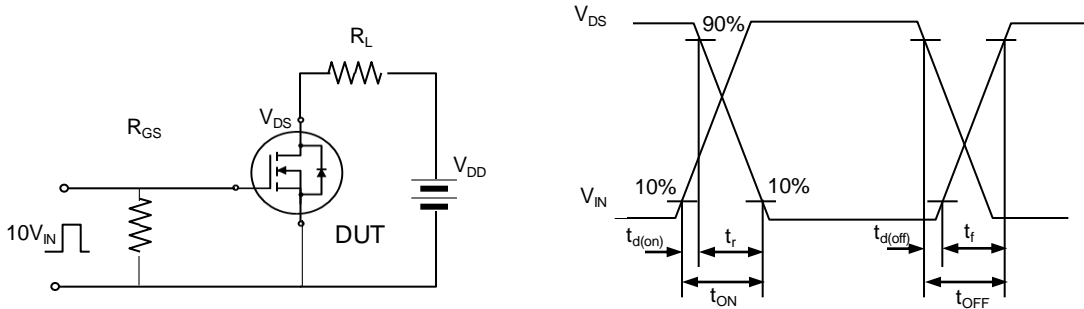

Fig 12. Unclamped Inductive switching test circuit & waveform

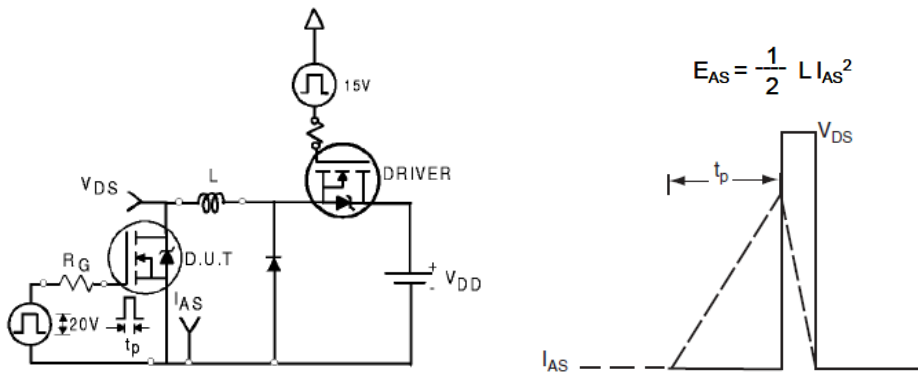
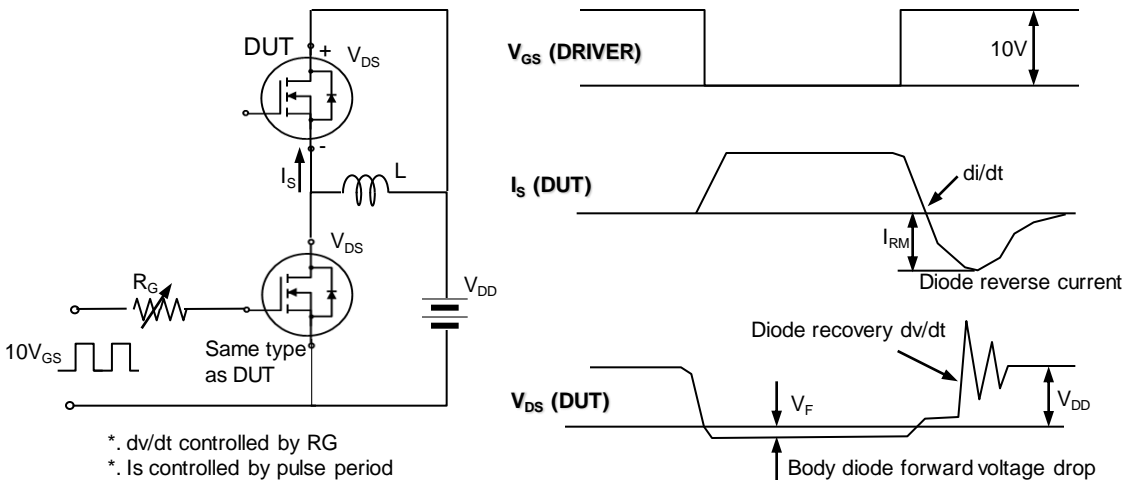

Fig 13. Peak diode recovery dv/dt test circuit & waveform





## Disclaimer

- ◆ SINAI assumes no responsibility for equipment failures that result from using products at values that exceed, even momentarily, rated values (such as maximum ratings, operating condition ranges, or other parameters) listed in products specifications of any and all SINAI products described or contained herein.
- ◆ Specifications of any and all SINAI products described or contained herein stipulate the performance, characteristics, and functions of the described products in the independent state, and are not guarantees of the performance, characteristics, and functions of the described products as mounted in the customer's products or equipment. To verify symptoms and states that cannot be evaluated in an independent device, the customer should always evaluate and test devices mounted in the customer's products or equipment.
- ◆ In the event that any or all SINAI products(including technical data, services) described or contained herein are controlled under any of applicable local export control laws and regulations, such products must not be exported without obtaining the export license from the authorities concerned in accordance with the above law.
- ◆ This catalog provides information as of Nov. 2014. Specifications and information herein are subject to change without notice.